

4 Poles

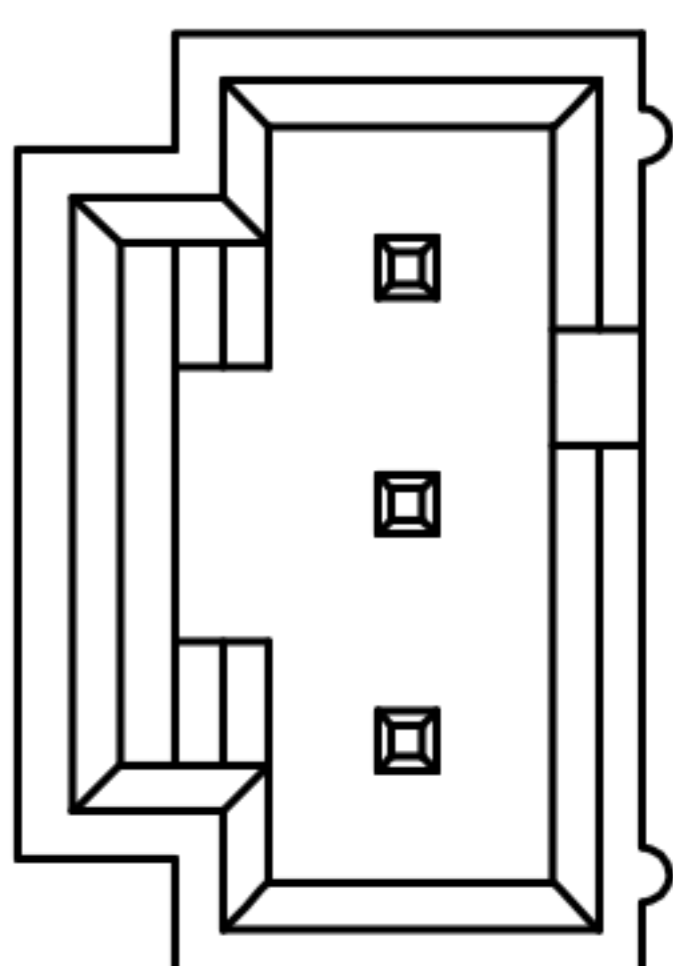

3 Poles

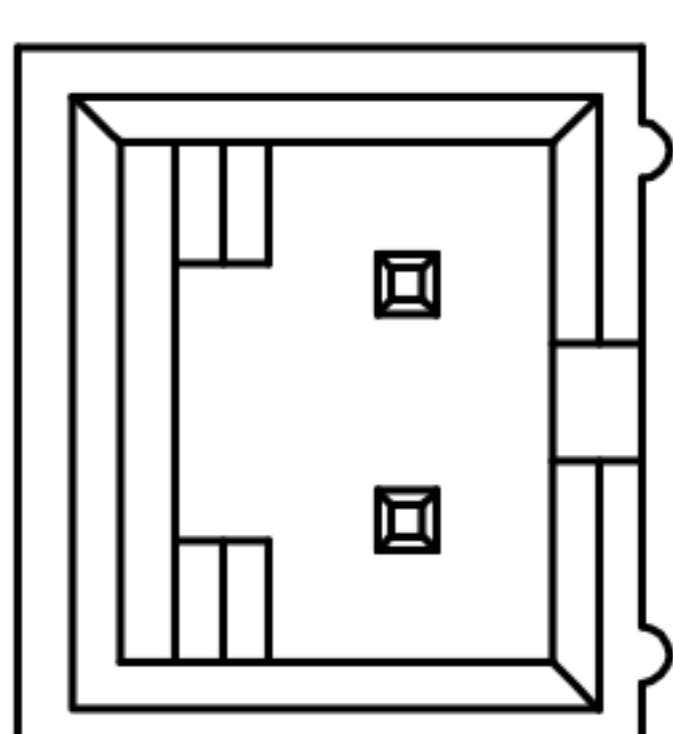

2 Poles

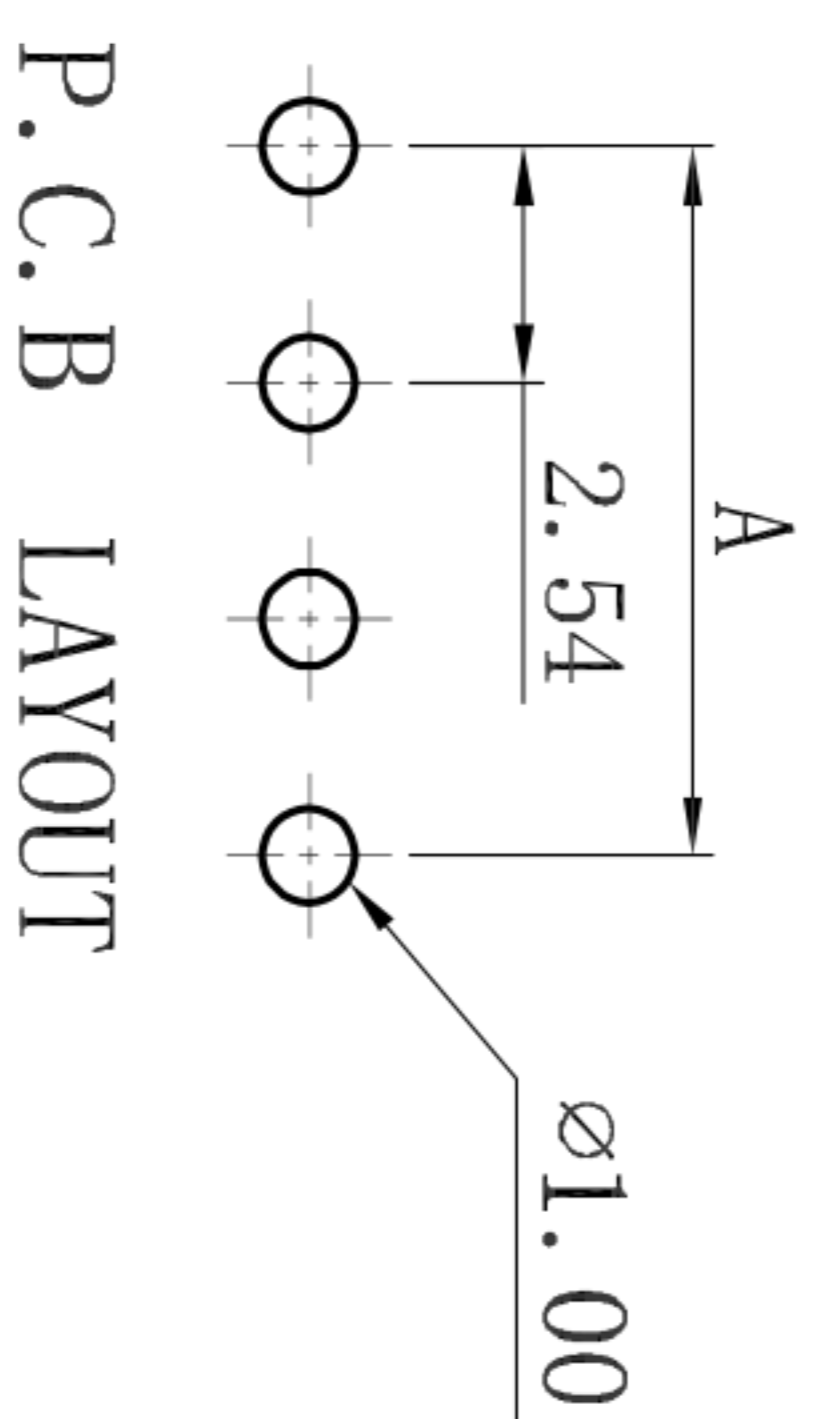
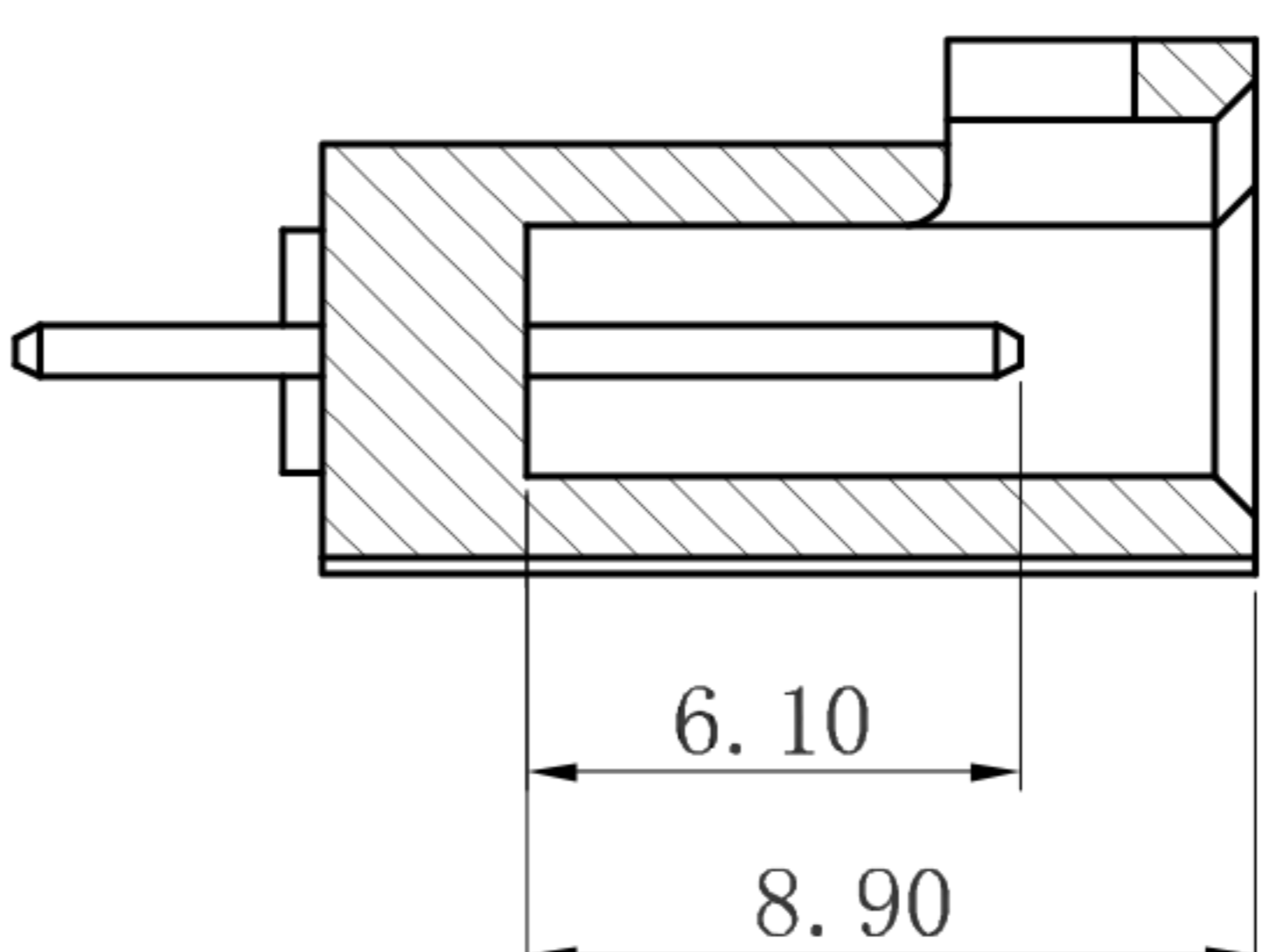
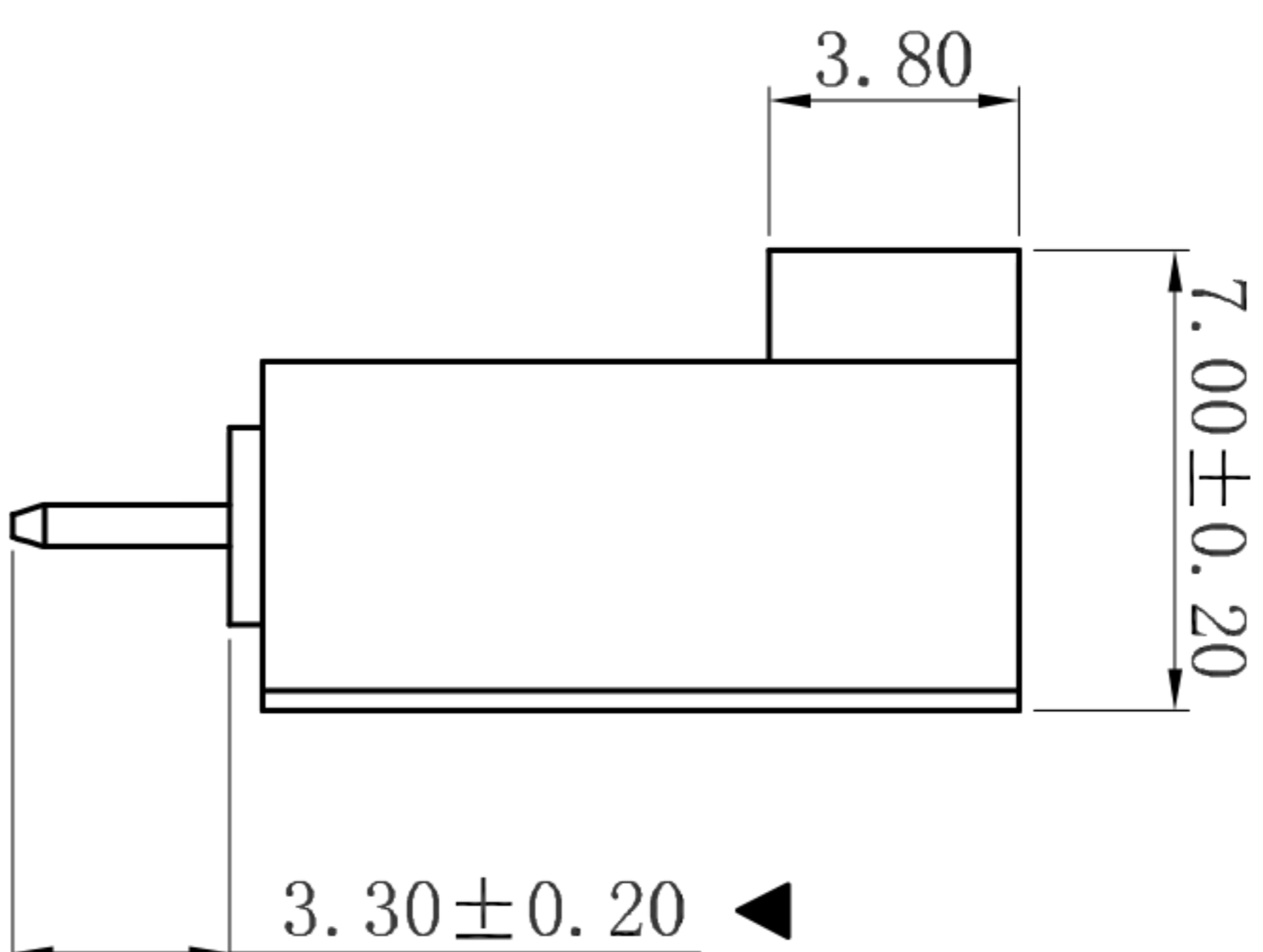
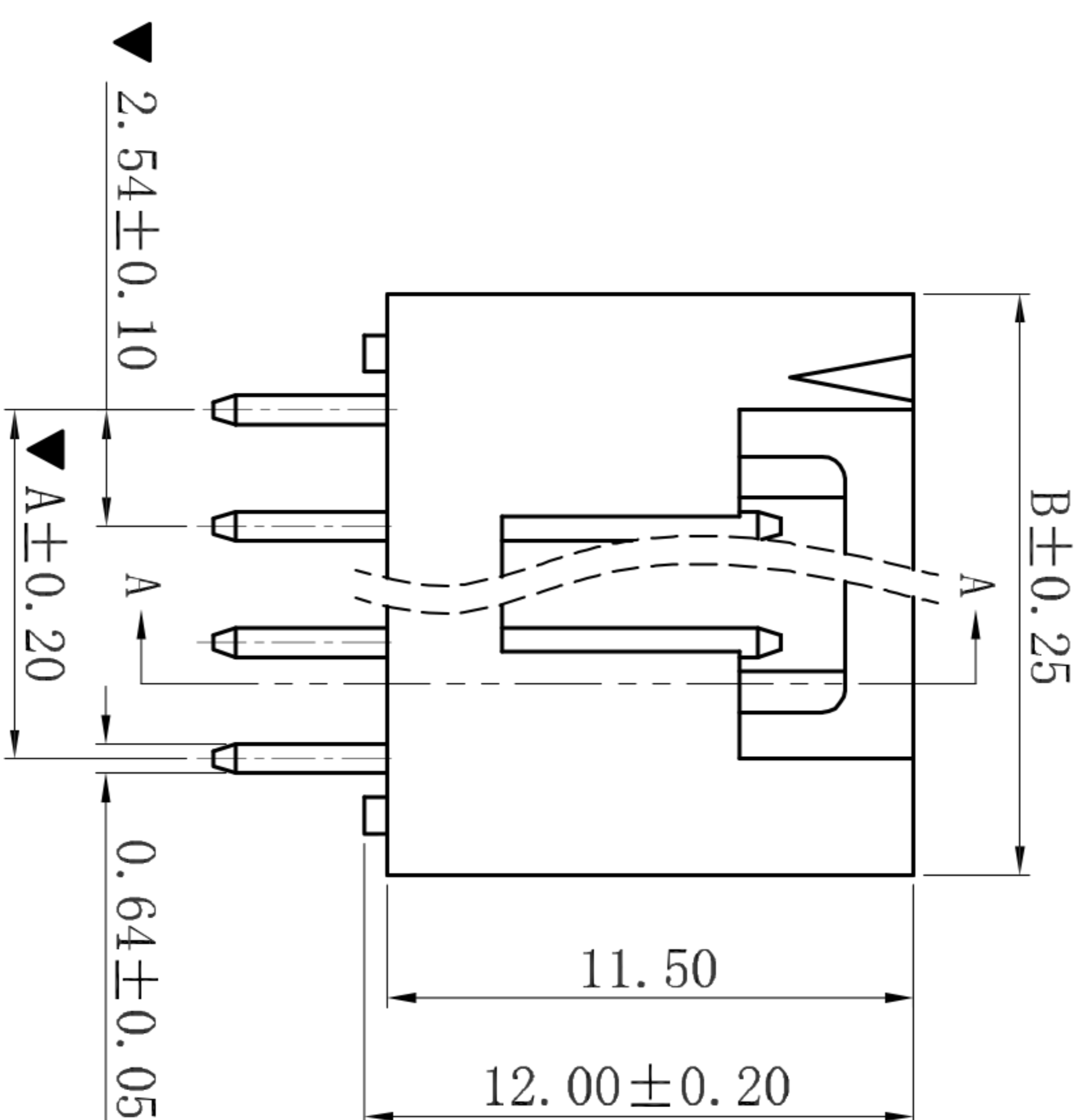

■ SPECIFICATIONS

- Voltage rating: 250V AC, DC
- Current rating: 5A, AC, DC
- Withstanding Voltage: 1500V AC/minute
- Insulation resistance: 1000M Ω min
- Temperature range: -25 $^{\circ}$ C~+85 $^{\circ}$ C
- Contact resistance: 20m Ω max

■ WAFER

- Part No. : W2545V-NP
- Poles : 02-20P
- Housing Material : PA66 15%GF UL94V-0 Black
- Pin Material : Brass
- Contact Area Plating: Gold-Flash
- The Dimension Marked “▼” Must Be Recorded

Poles	Dimension (mm)	
	A	B
02	2.54	7.62
03	5.08	10.16
04	7.62	12.70
05	10.16	15.24
06	12.70	17.78
07	15.24	20.32
08	17.78	22.86
09	20.32	25.40
10	22.86	27.94
11	25.40	30.48
12	27.94	33.02
13	30.48	35.56
14	33.02	38.10
15	35.56	40.64
16	38.10	43.18
17	40.64	45.72
18	43.18	48.26
19	45.72	50.80
20	48.26	53.34

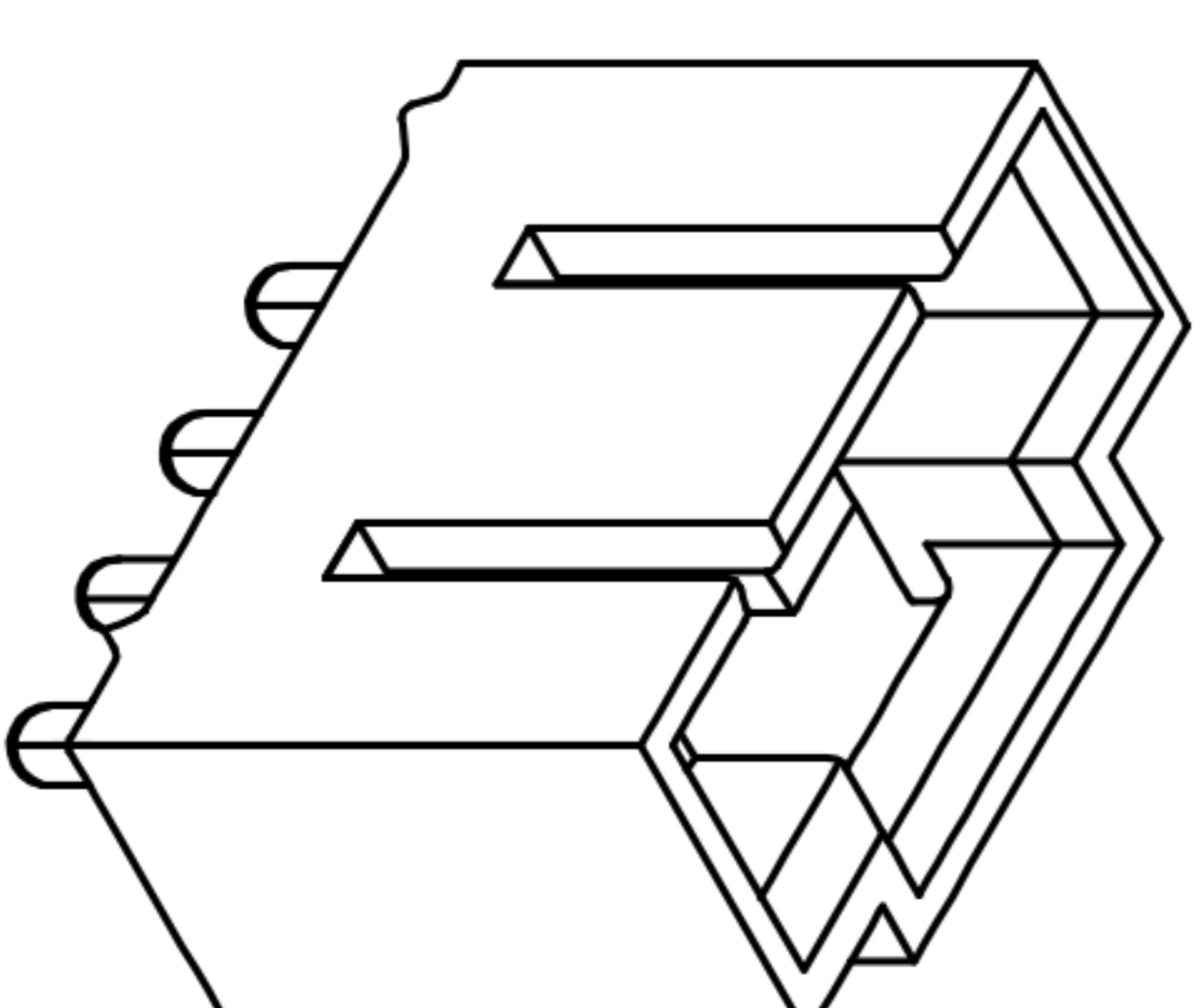

APPROVALS		DATE	TITLE:	
DRAWN	ZHIWEI.CHEN	2015.07.07	PART NO. GP01-2542WV-NP	
CHECKED			SCALE: 1:1	
APPROVALS			PROJ:	
TOLERANCES ARE		ANGLE	UNIT: mm	DRAWING NO.
30~以上	±0.30			
10~30	±0.20	±2'		
5~10	±0.15			
~ 5	±0.10			SHEET 1 OF 1
ECN NO.	REV.	DATE.	DESCRIPTION.	
	A		NEW	
			CHANGE.	
			CHECK.	
			APPRO.	



深圳市联丰电子有限公司
SHENZHEN LIANYING ELECTRONIC CO.,LTD